















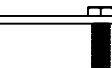

INSTALLATION INSTRUCTION
For Chevy C/K-series- Extended Cab 88-89
ITEM NO:4491

ATTENTION

1. Please read this installation instruction before installing this part.
When install it, please pay attention to protecting your vehicles.

2. When you use it, please check this parts at a fix time-lapse, such as one month or two month.

PARTS LIST

No	Name	Photo	Qty	Remarks	No	Name	Photo	Qty	Remarks
①	Mount Bracket1		2	lateral symmetry	⑨	Hex Nut		2	M12
②	Mount Bracket2		2	lateral symmetry	⑩	Hex Bolt		4	M10*25
③	Mount Bracket3		2	lateral symmetry	⑪	Flat Washer		8	M10
④	Mount Bracket4		2	lateral symmetry	⑫	Lock Washer		4	M10
⑤	"T"Bolt		2	M12*40	⑬	Hex Nut		4	M10
⑥	Hex Bolt		4	M12*120	⑭	"T"Bolt		4	
⑦	Flat Washer		6	M12	⑮	flat washer		16	M6
⑧	Lock Washer		6	M12	⑯	LOCK NUT		16	M6

Installation Diagram

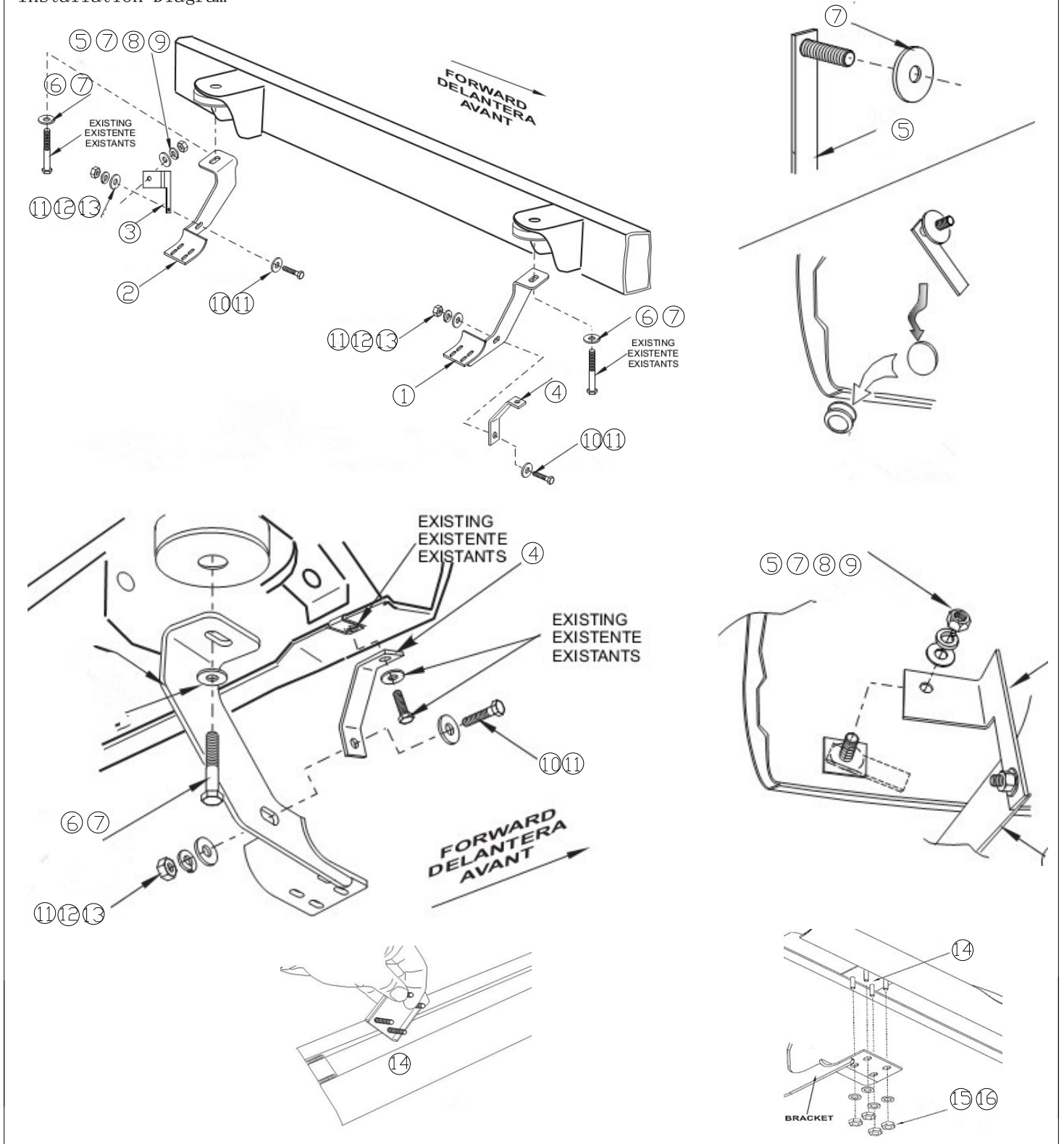

INSTALLATION STEPS

STEP 1: Check the parts in the box carefully if match above list .

STEP 2: Pls prepare the tools for installation, follow as: 10-12 wrench, 14-17 wrench .

STEP 3: Put the mount bracket into the girder of the car, and tighten it with 5 6 7 8 9 10 11 12 13.

STEP 4: Install the Side Bar to the mount bracket, and tighten it with T Bolt 14 15 16.

STEP 5: Installation is finished.