

Serial Number

Please read **BOTH** these Installation Instructions and the General Towing Instructions before attempting to install or operate this equipment.

- Blue Ox® towing products and accessories are intended to be installed by Blue Ox® Dealers who are familiar with our products and have the equipment and knowledge to do “fit work”. When necessary, Blue Ox® Dealers can be found at www.blueox.com or by contacting our Customer Care Department at (402) 385-3051.
- Many Blue Ox® Baseplates are designed to use existing holes and hardware to mount the baseplate to the towed vehicle. Even though bolts are there, do not assume they are adequate for baseplate mounting. Always use hardware supplied in the hardware kit or existing hardware specified in the Baseplate Installation Instructions.

Attachment Tab Height: 13 1/2”
Attachment Tab Width: 24”

Bolt Torque Specifications
Torque in Foot-Pounds for Metric Bolts

Bolt Size	Grade 8.8	Grade 10.9
6MM	6	8
8MM	16	22
10MM	31	40
12MM	54	70
14MM	89	117

Confirm the towability and pre-towing procedures for your vehicle with the owner’s manual or contact the vehicle’s manufacturer for specific towing procedures.

Bolt Torque Specifications
Torque in Foot-Pounds for Inch Bolts

Bolt Size	Grade 5	Grade 8
1/4”	10	14
5/16”	19	29
3/8”	33	47
7/16”	54	78
1/2”	78	119
5/8”	154	230



If the front of your vehicle looks different than this, call us at (402) 385-3051.

⚠ WARNING

Failure to read and follow these instructions could result in separation of the towed vehicle from the tow bar, causing property damage, loss of towed vehicle, personal injury or death.

BX2323

2006-11 Hyundai Accent

(No Foglights) Installation Instructions

Parts List

Ref. No.	Qty.	Part #	Description
1	1	61-6298	Weldment, Base Plate, BX2323
2	6	61-5208	3/8-16 Nut Plate with 14 inch Wire
3	6	201-0440	3/8-16 x 1 1/2" Hex Bolt, Grd. 5, ZP
4	6	203-0010	3/8" Lock Washer
5	1	201-0655	6mm-1.0 x 30mm Hex Bolt, Grd. 8.8, ZP
6	1	203-0008	1/4" Lock Washer, ZP
7	1	201-0654	#10-16 x 1 Self Drilling Screw, ZP
8	2	201-0553	1/4-20 x 1/2" Hx. Wshd, Type F Screw
9	2	201-0192	#10-32 x 1/2" Slot, Rd. Hd. Screw
10	2	203-0054	#10 Lock Washer
11	2	202-0047	#10-32 Hex Nut
12	2	101-5822	Adapter, 4 Way Connector
13	2	62-3468	Attachment, Assembly, SF/SB (R)
	2	290-0437	Receiver, Cap Plug, Blk (Not Shown)
	2	229-0359	Quicklink, 3/8, ZP (Not Shown)
	2	226-0046	Baseplate Safety Cable, 36" CL III (Not Shown)

Tools Required

Loctite® RED
 6mm Socket
 10mm Socket
 12mm Socket
 9/16" Socket
 13/32" Drill Bit
 1 1/4" Hole Saw
 Reciprocating Saw
 Vise Grips
 Hack Saw Blade
 Phillips Screwdriver
 Pliers

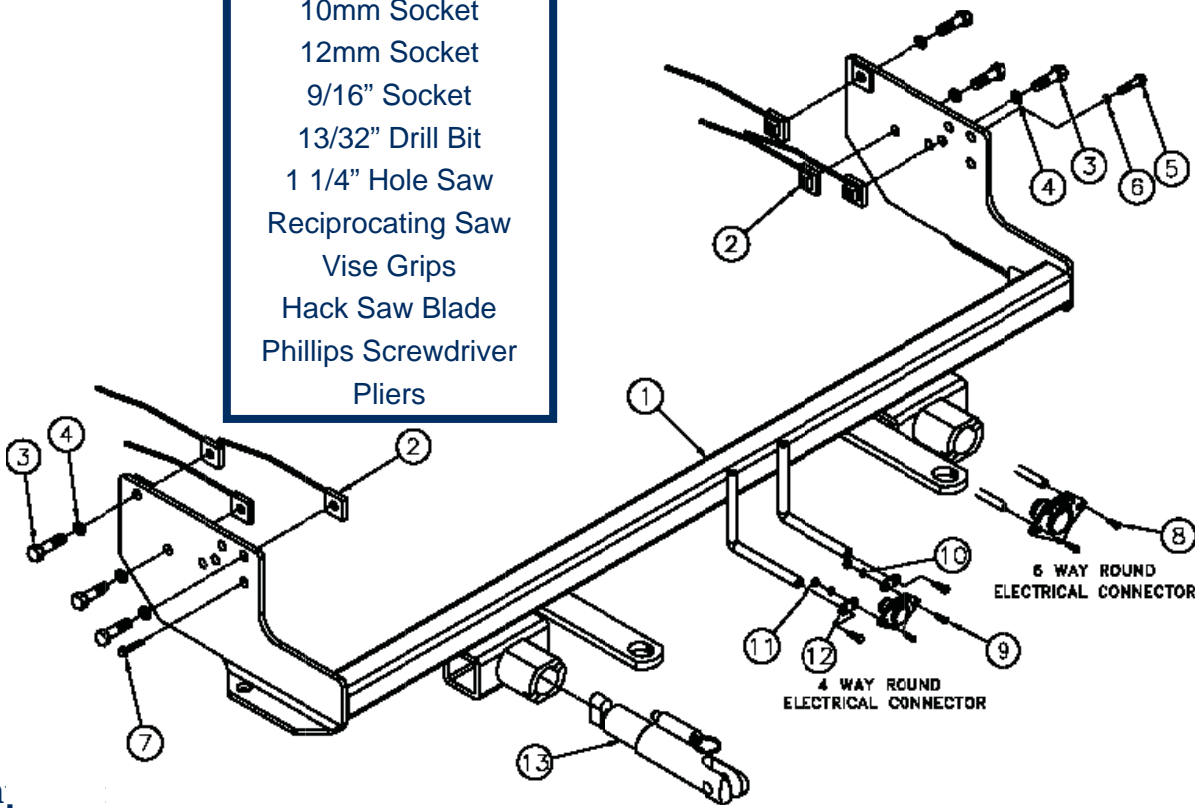

Im

Use only genuine factory replacement parts on your baseplate. Do **NOT** substitute homemade or non-typical parts. If a bolt is lost or in need of replacement, for your safety and the preservation of your baseplate, be sure to use a replacement bolt of the same grade (In most cases it will be Grade 5, please reference the parts list above). Replacement parts may be ordered through your nearest Blue Ox® Dealer or Distributor. Failing to follow and/or altering these installation instructions in either installation or required equipment will void the manufacturer's warranty. Towing behind a non-motorized vehicle will void the

BX2323
2006-11 Hyundai Accent
(No Foglights) Installation Instructions

Attachment Tabs:

Due to the design of the removable tabs, the RangeFinderII tow bar can not be used. Adapters, except the BX8833 and BX88151, can not be used with this baseplate.

Installation Notes:

The radiator cover, fascia, air baffle, air bag sensor, washer reservoir, metal bumper and air bag sensor are removed. The grille is trimmed. Drilling is required. The air bag sensor bolt is not reinstalled.

The dimensional variations between otherwise identical vehicles can be considerable.

While the baseplate was designed for easy installation, it may be necessary to tailor the baseplate slightly to compensate for auto manufacturer's tolerances. These minor adjustments may include filing a hole slightly, bending electrical rods or bending end plates.

The BX8869 Bulb and Socket Wiring Kit is recommended for this vehicle.



Possible Location for the BX8869 Bulb and Socket Wiring Kit.

Handling of some cosmetic parts when installing this product may require the use of protective covers, rags, specialty tools, etc. to prevent damage.

Installation Instructions:

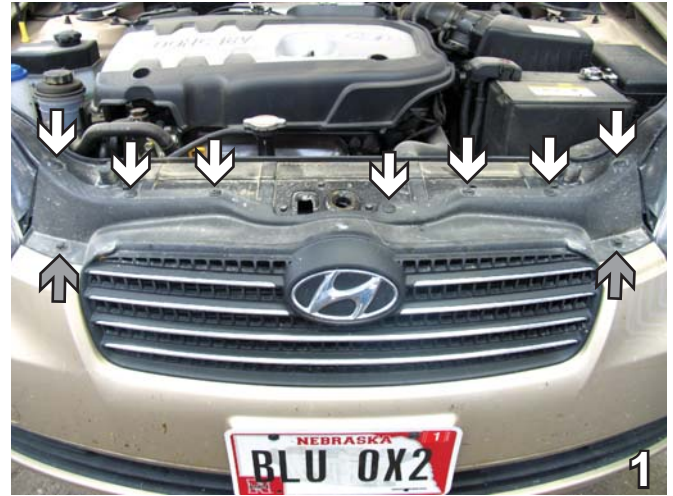

1. Remove seven Phillips pushpins from the top of radiator cover (see white arrows). Using the 10mm socket, remove two metric bolts (see grey arrows) from radiator cover and lift to remove. Set bolts, pushpins and radiator cover aside to be reinstalled later.



2. Using the 8mm socket, remove one metric bolt from edge of fascia, just inside wheel well. Do this to both sides of the vehicle. Set bolts aside to be reinstalled later.

BX2323
2006-11 Hyundai Accent
(No Foglights) Installation Instructions



3. Remove two pushpins from the bottom corner of fascia. Do this to both side of the vehicle. Set pushpins aside to be reinstalled later.



4. Remove two pushpins from the tabs on the bottom center of fascia. Pull upper corners of fascia to the side to release from upper two tabs. Do this to both sides of the vehicle. Pull fascia forward to remove. Set pushpins and fascia aside carefully to be reinstalled later.



5. On the driver's side, use the 10mm socket to remove two metric bolts from the air baffle. Set bolts and air baffle aside to be reinstalled later.



6. On the passenger's side, disconnect the hose and electrical connection from the washer reservoir. Using the 10mm socket, remove three metric bolts from the washer reservoir. Remove washer reservoir. Set bolts and reservoir aside to be reinstalled later.

BX2323
2006-11 Hyundai Accent
(No Foglights) Installation Instructions

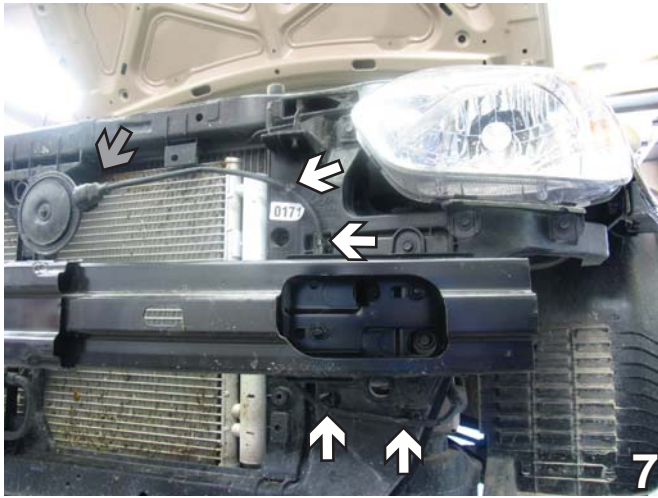

7. Just above the center of metal bumper, press the clip on the horn cable to release it (see grey arrow). Disconnect the cable from four tie clips along the horn cable - between the horn and the air bag sensor on the driver's side. Move the cable out of the way to prepare the area for baseplate installation (leave cable connected to the air bag sensor and move out of the way to prepare area for baseplate installation).



8. On the passenger's side, remove the electrical grounds (see white arrows) and move out of the way for baseplate installation.

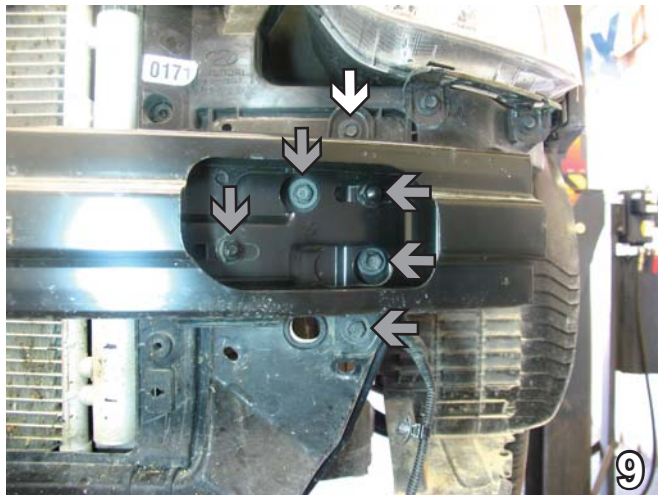

9. Using the 10mm socket, remove one metric bolt from top section of metal bumper bracket (see white arrow). Using the 12mm socket, remove five metric bolts from the metal bumper bracket (see grey arrows). Do this to both sides of the vehicle. Pull metal bumper bracket forward to remove. Set bolts, metal bumper and bracket aside to reinstall later.



10. Using the 1 1/4" hole saw, drill one hole through the frame end into the frame rail (to insert nut plates later). *Note: We recommend spraying the surface with an anti-corrosive paint after drilling.* Do this to both sides of the vehicle.

When using power drills be aware of the dangers of torque and drill bit length.

BX2323
2006-11 Hyundai Accent
(No Foglights) Installation Instructions



11. On the driver's side, remove the electrical grounds (see white arrows) and move out of the way for baseplate installation. Using the 6mm socket, remove the metric bolt from the air bag sensor (see grey arrow) and move sensor out of way. Set bolt aside to be reinstalled later.



12. Using the reciprocating saw, make a horizontal cut in the radiator support ribbing flush with the bottom of the frame rail. Make another horizontal cut on the radiator support ribbing 3 1/2" down. Using the pliers, flatten the ribbing area between the cuts (see grey arrows). Using the pliers, flatten a 1/2" section of the frame support ribbing where it meets the frame rail (see white arrow). Do this to both sides of the vehicle.

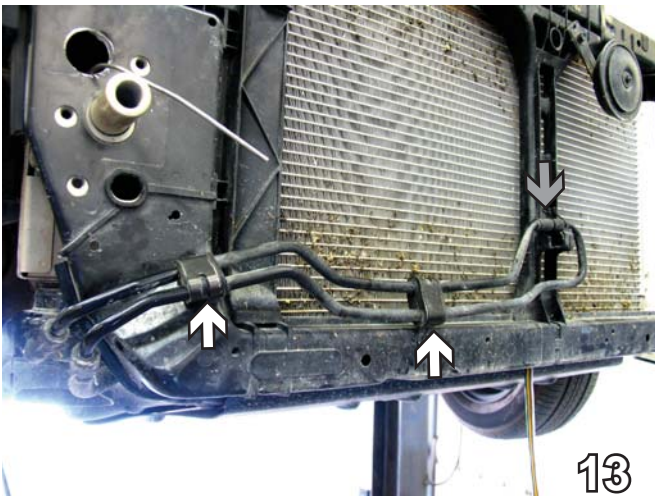

13. Bend coolant line brackets (see white arrows) upward toward radiator to make room for baseplate installation. Using zip ties, secure the bushing of upper section of coolant line (see grey arrow) to cross member of the radiator support bar.

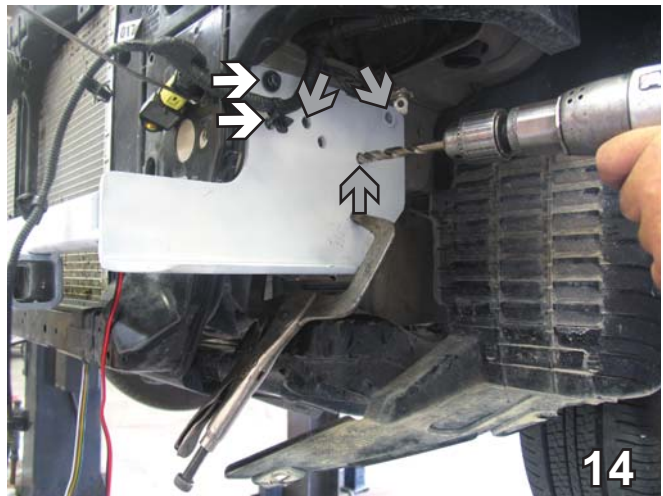

14. On the driver's side, align front two baseplate holes with existing air bag sensor holes (see white arrows). Insert existing bolt from air bag sensor into upper, front hole. Clamp baseplate into place using vise grips. Using baseplate as a template, drill three holes into frame rail with the 13/32" drill bit (see grey arrows). **Baseplate painted white for illustration. Actual baseplate will be powder-coat black.**

BX2323
2006-11 Hyundai Accent
(No Foglights) Installation Instructions

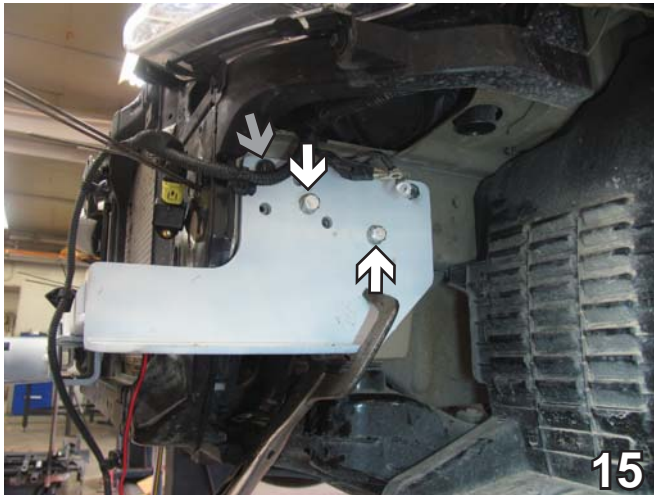

15. On the driver's side, insert 3/8-16 nut plates through frame end hole. Align to the lower two drilled holes (see white arrows). Install 3/8-16 x 1 1/2" hex bolts with 3/8" lock washers and tighten. Trim excess nut plate wire. Remove air bag sensor bolt (see grey arrow).



16. On the passenger's side, align baseplate with washer reservoir hole and insert existing bolt (see white arrow). Using the baseplate as a template, drill three holes into the frame rail with the 13/32" drill bit (see grey arrows). Insert 3/8-16 nut plates through frame end hole. Insert 3/8-16 x 1 1/2" hex bolts and 3/8" lock washers and tighten to nut plates. Trim nut plate wires. Remove washer reservoir bolt.

BE SURE TO USE LOCTITE® RED ON ALL BOLTS BEFORE TIGHTENING. TIGHTEN ALL BOLTS ACCORDING TO THE TORQUE CHART ON THE FRONT PAGE OF THESE INSTRUCTIONS OR ON PAGE 3 OF THE BASEPLATE TOWING GENERAL INSTRUCTIONS.



17. Reinstall metal bumper and bracket. Route the horn cable through the side of the metal bumper and out through backside of the metal bumper (see white arrows). Connect the horn cable (see grey arrow).



18. On the driver's side, reinstall air baffle's existing bolts to upper rear and lower middle baseplate holes (see grey arrows). Reconnect horn cable to air bag sensor. Reinstall sensor to the top front baseplate hole and insert sensor pin to lower front hole. Reconnect electrical grounds with the 6mm hex bolt and 1/4" lock washer (see white arrow).

BX2323
2006-11 Hyundai Accent
(No Foglights) Installation Instructions

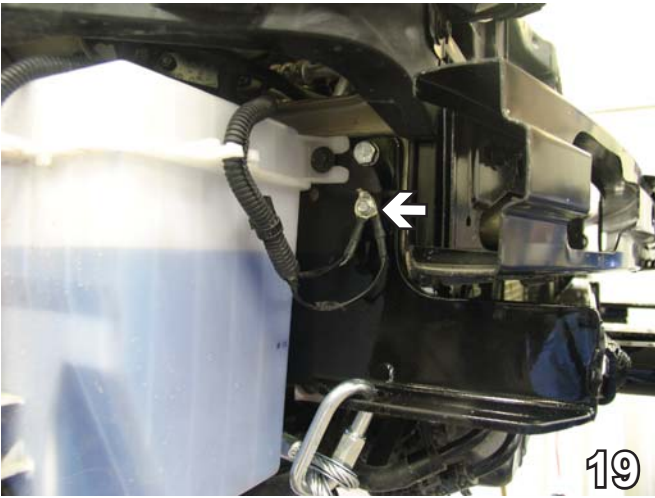

19. On the passenger's side, reinstall washer reservoir using existing bolts. Reconnect electrical grounds to the lower front bolt hole using the #10-16 x 1 self drilling screw (see white arrow).



20. Align the fascia to its original position and, using a hack saw blade, trim necessary openings in the grille for the attachment tabs. Do this to both sides of the vehicle.



21. Attach the permanent baseplate safety cables to the provided convenience link on the baseplate (see grey arrow). The photo above shows the recommended installation of the cables to frame of vehicle (see white arrow). Additional options may interfere with suggested mounting; in this case secure the cables to a solid piece of the frame as described in the instructions included with the permanent baseplate safety cables. Be sure the safety cables do not rub against any hoses or moving parts. Do this to both sides of the vehicle.

Be sure that **ALL** electrical connections are plugged in properly and functioning **BEFORE** installing the fascia.

DEALER or INSTALLER:
Be certain the user receives the instruction sheets for their products.

22. Reinstall the fascia, radiator cover, pushpins and bolts.

Install the tow bar and safety cables according to the instructions provided in their packages. When demonstrating this to the customer, be sure to include all the contents and packages.

Do **NOT** substitute other devices if the tow bar pins and clips are misplaced.

BX2323
2006-11 Hyundai Accent
(No Foglights) Installation Instructions

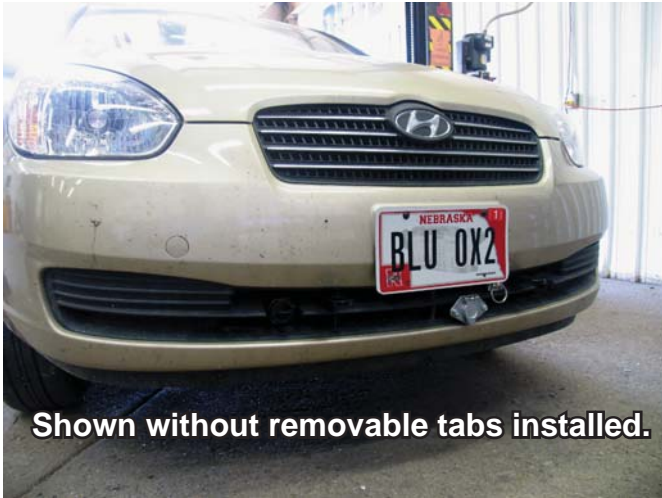

Shown without removable tabs installed.

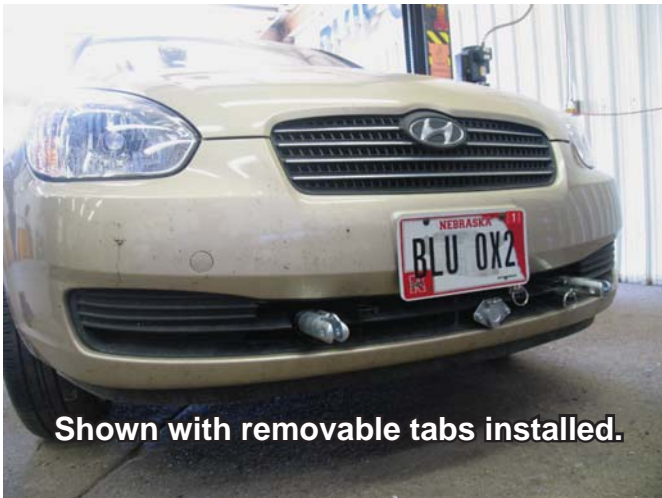

Shown with removable tabs installed.

CUSTOMER SERVICE COMMITMENT

Blue Ox is committed to providing you with exceptional customer care throughout your lifetime with our products. Our team is here to assist you with any questions you may have regarding the performance of your product. Simply call 1-(402) 385-3051 and you can speak with our customer care team.

Additionally, please visit our website to see which rallies our Destination America team will be attending. For a nominal fee, our service technician will service your towing system to ensure it's in proper working condition. Also as a commitment to our customers, should you visit our factory you can stay at our full service Blue Ox campground at no charge along with enjoying a factory tour.

Again thank you for being our customer and for the confidence you have shown in the performance of our products. It is because of customers like you we enjoy the success we have today.

If the baseplate is in an accident, it must be replaced. DO NOT use it again! An accident can cause unseen damage and using it again could result in more damage or serious injury. DO NOT use the baseplate if it is damaged or missing parts.



© 2006, 07, 08, 09, 10 Blue Ox
One Mill Road, Industrial Park
Pender, Nebraska 68047
Phone: (402) 385-3051
Fax: (402) 385-3360
www.blueox.com
12/7/10