



SwayPro™

Owner's Manual & Installation Instructions

Serial Number



Standard Hitch Head w/ Clamp-On Rotating Latches

BXW0350

350 lbs. maximum tongue weight capacity

BXW0550

550 lbs. maximum tongue weight capacity

BXW0750

750 lbs. maximum tongue weight capacity

BXW1000

1000 lbs. maximum tongue weight capacity

BXW1500

1500 lbs. maximum tongue weight capacity

BXW2000

2000 lbs. maximum tongue weight capacity

NOTE: A minimum tongue weight of 200 lbs. is required

THANK YOU

for purchasing a SwayPro™ from Blue Ox®. Please read the manual to insure your installation is as simple and trouble-free as possible. Keep your sales receipt and the manual in a safe place for future reference.

SwayPro™ Owner's Manual & Installation Instructions

Welcome to the Blue Ox® Family

The SwayPro™ is a revolutionary hitch that not only handles weight distribution but sway prevention as well by using the combination of loaded spring bars, easy to use rotating latches and an integrated hitch head. As the trailer tries to sway it puts a heavier load on one side of the bars, as this happens the spring bars will pivot on the hitch head and balance each other preventing the trailer from swaying. The SwayPro™ will also conquer weight distribution at the same time, putting more weight on the towing vehicles front tires which increases steering control and braking giving you a safer and easier driving experience. Your SwayPro™ is backed by a limited lifetime limited warranty. **Any unauthorized modifications to your SwayPro™ may void the warranty.**

Please read all of the technical documents, warnings, tips, and notes in this manual before operating your SwayPro™ for the first time. Improper installation, use and/or maintenance may result in malfunction causing personal injury or property damage. Please fill out and return your warranty card. For future reference your serial number is located on the outside of the manual packaging and is also located on the top of the hitch head of your SwayPro™.

Features & Benefits

- **Open Head**
The open head design provides easy access for tightening the hitch ball.
- **Powder Coat Finish**
The powder coat finish provides a professional appearance, aids in rust prevention, and prolongs the life of the product.
- **Rotating Latches**
Rotating latches clear obstacles that are mounted above the frame.
- **Greaseless Bars**
Grease is captured inside the bar pivots. No messy bars to deal with.

Frequently Asked Questions

What size ball shanks can be used?

Answer: The SwayPro™ accepts 1" or 1-1/4" ball shanks.

Does sway prevention require adjustment?

Answer: No, sway prevention is built into the SwayPro™ system and no adjustments are required.

What is gross trailer weight?

Answer: Weight of trailer (dry) + liquids (water, propane, sewage) + cargo. Measure gross trailer weight with a fully loaded trailer on a level surface, preferably on a public truck scale.

What is tongue weight?

Answer: Downward force exerted on the hitch ball by the trailer ball coupler. Measure tongue weight with a fully loaded trailer on a level surface with trailer ball coupler at tow height.

Why do the bars bend? Will they stay bent?

Answer: The spring bars are designed to deflect 2"-3" on a properly set system. This creates the necessary load on the spring bars to achieve an enjoyable ride. No, the spring bars will always return back to straight.

What size bars do I have?

Answer: The bars are marked with a dot system on the shank end to identify the weight rating.

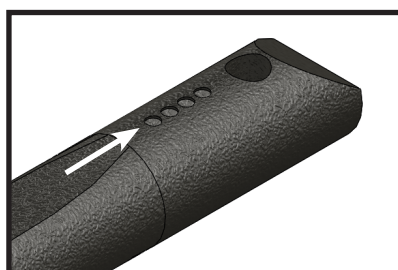

- 350lb Bar = No Dots
- 550lb Bar = (1) Dot
- 750lb Bar = (2) Dots
- 1000lb Bar = (3) Dots
- 1500lb Bar = (4) Dots (shown)
- 2000lb Bar = (5) Dots

SwayPro™ Owner's Manual & Installation Instructions

Tools Required

Torque Wrench
Tape Measure
1/2" Wrench
3/4" Wrench
1-1/8" Wrench
1-1/8" Socket

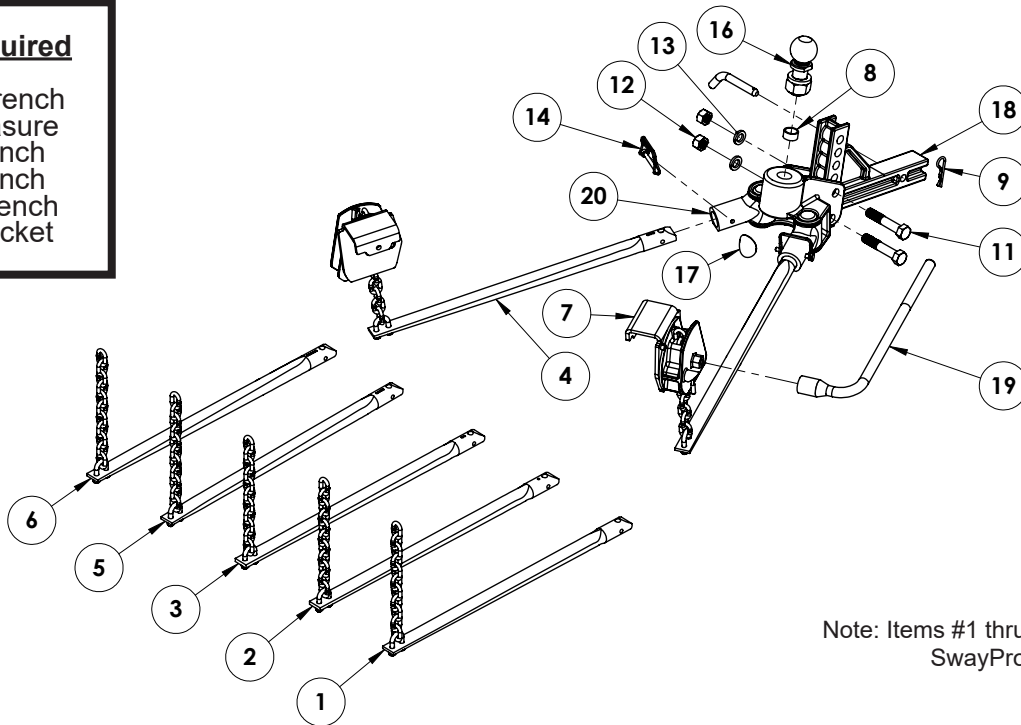

Note: Items #1 thru #6 depend on your SwayPro™ model

Item No.	Part No.	Description	Qty.
1.....	62-3935	350 Lb. Spring Bar	2
2.....	62-3538	550 Lb. Spring Bar	2
3.....	62-3537	750 Lb. Spring Bar	2
4.....	62-3536	1,000 Lb. Spring Bar	2
5.....	62-3558	1,500 Lb. Spring Bar	2
6.....	62-3932	2,000 Lb. Spring Bar	2
7.....	62-3774	Clamp-On Rotating Latch	2
8.....	107-3042	1-1/4" OD x 1-1/32" ID x 5/8" Spacer Tube	1
9.....	200-1483	5/8" OD x 3" Effective Pin with Clip	1
	200-1701	5/8" OD x 4" Effective Pin with Clip (BXW2000 only).....	1
10.....	201-0054(not shown) ...	1/2"-13 x 2" Square Head Set Screw	2
11.....	201-0914	3/4"-10 x 4" Hex Head Bolt, Grade 5, ZP	2
12.....	202-0007	3/4"-10 Hex Nut, ZP	2
13.....	203-0014	3/4" Lock Washer, ZP	2
14.....	229-0440	5/16" x 2-1/2" Eff Spring Lock Pin	2
15.....	229-0512(not shown) ...	1/2" Quick Link, ZP	2
16.....	229-1174	2-5/16" x 1-1/4" Shank, 20K Chrome Hitch Ball.....	1
17.....	292-7198	2" DIA Aluminum Blue Ox Embossed Decal	1
18.....	299-0717	Standard 2" Receiver Hitch Mount.....	1
	299-0789	2-1/2" Receiver Hitch Mount (BXW2000 only).....	1
19.....	299-0786	Rotating Latch Wrench	1
20.....	299-0844	Hitch Head Assembly.....	1

Note: The 2- quick links included are for receiver hitches that the safety chains will not reach. Install quick links on safety chain loops mounted to receiver hitch and tighten.

Note: If the trailer structure interferes with the rotating latches pre-installed set screws, replace them with the shorter 1/2"-13 x 2" set screws provided.

Important:

Use only genuine factory replacement parts on your SwayPro™. Do **NOT** substitute homemade or non-typical parts. If a bolt is lost or in need of replacement, for your safety and the preservation of your SwayPro™, be sure to use a replacement bolt of the same grade (In most cases it will be Grade 5, please reference the parts list above). Replacement parts may be ordered through your nearest Blue Ox® Dealer or Distributor. Failing to follow and/or altering these installation instructions in either installation or required equipment will void the manufacturer's warranty.

Installation

1. Park the towing vehicle and trailer in a straight line on firm, level ground. Air-ride shock absorbers, air springs, or automatic leveling systems on towing vehicle should be disabled or deflated to the manufacture's minimum recommended pressure prior to SwayPro™ installation. Unhook the trailer from the towed vehicle and level. Remove the existing receiver hitch.
2. Insert the hitch mount receiver shank into the towing vehicle receiver and secure with the 5/8" x 3" pin and clip.
3. A 2-5/16" x 20K ball is pre-installed on the hitch head. If needed use the 1.031" ID spacer tube for 1" ball shank. **The hitch ball capacity must meet or exceed the gross trailer weight rating.**
4. Level the trailer and then measure the coupler height. Install the hitch head onto the receiver shank, using the 3/4"-10 bolts, 3/4" lock washers and 3/4"-10 hex nuts. Measure the hitch head ball height. The ball height needs to be the same or 1" higher than the trailer coupler height, adjust as necessary. Torque the 3/4"-10 bolts to 250 ft/lbs.

Note: Ram Truck owners please reference the Trailer Towing section of your vehicle owner's manual for proper hitch set-up instructions. Also, it is recommended for optimal towing performance to set the ball height 2" higher than the top the trailer coupler.

5. Couple the trailer to the hitch head by placing the trailer coupler onto the hitch ball per the manufacturer's instructions.
6. Measure 29" back from the center of the ball coupler and mark this point on the trailer tongue frame work on both sides. Center and mount the rotating latches to the trailer frame over the marked areas. Remove or relocate any obstructions on the trailer tongue framework if necessary. Finger tighten the bolts on the rotating latch at this time.
7. Insert the spring bars into the bar pivots, insert pin and snap clip into place to lock bars in place.
8. After verifying that the rotating latches are in the proper position, torque the 1/2"-13 square head set screws against the trailer tongue framework to 40 ft/lbs and tighten the jam nut. **(Do NOT use Loctite® Red on set screw.)**

IMPORTANT: The spring bar chain must be straight up and down in the center of the rotating latch when the towing vehicle and trailer are aligned. Reposition the rotating latch along the trailer frame if necessary.

9. Release the rotating latch by rotating or pulling out on the lock pin handle. Rotate the bracket using the wrench that was provided and turn clockwise until the chain slot is on the bottom. Insert the 9th chain link from the top (opposite the u-bolt) into the slot of the latch. Using the wrench, rotate the latch counterclockwise until the lock pin engages in the lock pin hole.

Note: Adjustments to the number of links used may be necessary due to certain driving conditions and/or changes to the trailer after initial setup. Advancement to the 10th or 11th link from the top is recommended to compensate for these changes.

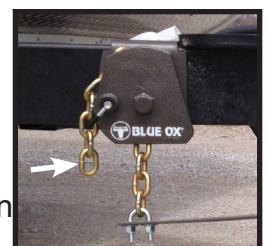

⚠ Caution must be used when unlatching due to the potential of injury if the tension of the spring bar is suddenly released the wrench will rotate quickly. Hold the wrench firmly as the rotating latch bracket will rotate downward causing a quick jerk on the wrench. Rotate slowly and firmly.

Installation (Cont'd)

10. Determine if the towing vehicle is level. If necessary, adjust the chains links.
 - A. Support the weight of the trailer tongue with the trailer jack.
 - B. Unlock the rotating latch bracket and release the spring bar tension on the chains.
 - C. Adjust chain to tighten or loosen one (1) link at a time.
 - D. Reapply the spring bar tension on the chains by using the wrench to rotate the rotating latches in a clockwise direction until the lock pin engages in the lock pin hole.
 - E. Lower the front of the trailer allowing the tongue weight of the trailer to be supported by the towing vehicle.

Repeat the above steps until the towing vehicle is level.

11. If the trailer is not level, determine how much and in which direction. Each hole raises or lowers the front of the trailer 1-1/2". Level the trailer by:
 - A. Support the weight of the trailer tongue with the trailer jack.
 - B. Unlock the rotating latch bracket and release the spring bar tension on the chains.
 - C. Uncouple the trailer.
 - D. Remove the 3/4" fasteners from the hitch head.
 - E. Move the hitch head on the receiver hitch mount either up to raise the front of the trailer or down to lower the trailer.
 - F. Replace the 3/4" fasteners in the appropriate holes and torque to 257 ft/lbs.
 - G. Couple the trailer to the hitch.
 - H. Support the weight of the trailer tongue with the trailer jack.
 - I. Reapply the spring bar tension on the chains by using the wrench to rotate the rotating latches in a clockwise direction until the lock pin engages in the lock pin hole.
 - J. Lower the front of the trailer allowing the tongue weight of the trailer to be supported by the towing vehicle.

Repeat the above steps until the trailer is level.

12. Verify that the trailer and the towing vehicle are level. If not, see the Troubleshooting section.



Operation

Hooking Up

1. Park the towing vehicle and trailer in a straight line on firm, level ground.
2. Install the hitch head/receiver mount assembly into the towing vehicle receiver tube and secure with the 5/8" x 3" pin and clip.
3. Couple the trailer to the hitch head.
4. Install both spring bars into the bar pivot tubes.
5. Confirm that both of the rotating latches are tight on the tongue.

Note: Before each tow, confirm that all bolts are tightened to specified torque specs.

6. Support the trailer tongue weight with the trailer jack to ease the tension on the spring bar chains and allow for easier latching. Attach the spring bar chains to the rotating latches with the appropriate chain link. Apply tension to the spring bar by using the wrench to rotate the latch counter-clockwise until the locking pin on the latch engages. Do this on both sides of the trailer.

NOTE: If the trailer and/or axle weight has changed since your last trip, adjustments to the spring bar chains may be necessary.

Unhooking

1. Park the towing vehicle and trailer in a straight line on firm, level ground.
2. Support the trailer tongue weight with the trailer jack to ease the tension on the spring bar chains and allow for easier unlatching. Place excess chain over top of the latch. While holding the wrench firmly, release the locking pin handle on the latch by rotating or pulling out on it. Rotate the latch clockwise until the chain is released from the latch. Do this on both sides of the trailer.



The latch will rotate quickly when the locking pin is released. Ensure you have control of the wrench when releasing.

3. Disconnect the spring bars from hitch head by removing locking pins from each side. Remove spring bars from pivot tubes.
4. Unhook the trailer coupler from the hitch head.
5. Remove the hitch pin and clip from the hitch receiver.
6. Remove the hitch head/receiver mount assembly from the receiver tube.



WARNING

DO NOT exceed the vehicle manufacturer's specification for trailer gross vehicle weight or tongue weight as this may cause a serious accident and/or injury while towing. Also, be aware that some receiver hitch manufacturers have different weight capacity ratings depending on the use of a weight distribution hitch or not.

SwayPro™ Owner's Manual & Installation Instructions

Troubleshooting

Issue: After coupling the trailer to the hitch head, the tow vehicle squats and the front of the trailer dips.

Resolution: If necessary, raise the chains of the spring bars up by one link.

Issue: After coupling the trailer to the hitch head, the tow vehicle is level but the front of the trailer dips.

Resolution: Adjust the hitch mount receiver higher. Each adjustment up or down equals 1-1/2".

Issue: There is excessive sway.

Resolution: Excessive sway may indicate that the trailer is improperly loaded. As a guideline, the tongue weight should be 10-15 percent of gross trailer weight. If it is not, redistribute the weight accordingly. If you encounter continuous sway or swaying that does not dissipate quickly, adjust the load.

Resolution: For all truck models with factory sway control, it is suggested that the sway control be disabled for the best performance of the Blue Ox® SwayPro™.

Issue: The ride is excessively rough.

Resolution: Spring bar chains are too tight or the spring bars are too stiff for your tongue weight. Be sure the spring bar chains are set properly. Verify that the spring bars are properly rated for your tongue weight.

Issue: Experiencing excessive tow vehicle movement.

Resolution: Recommend that the tow vehicle tires are inflated to 90% of max inflation state on tire side wall.

Support the Trailer Safely While Making Any Adjustments

Properly Adjusted System

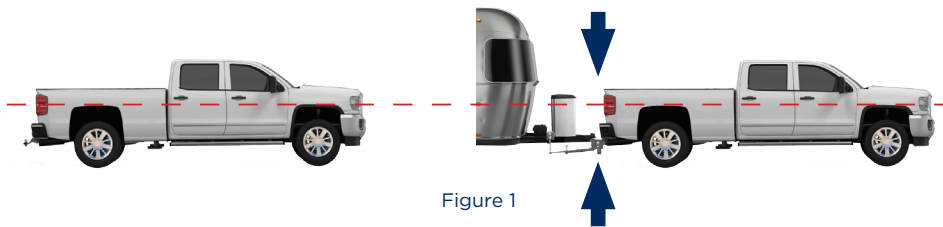

Overly Adjusted System

Light on the rear and heavy on the front - loosen chains, one link at a time, until the towing vehicle is level.

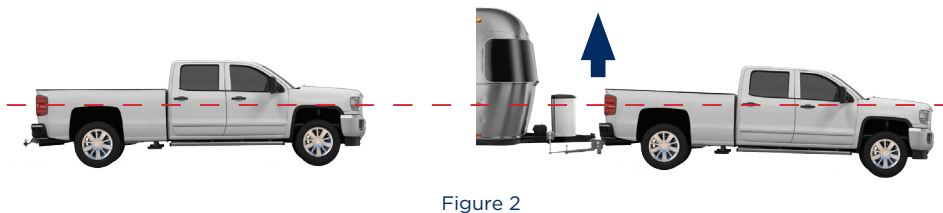

Under Adjusted System

Heavy on the rear and light on the front - tighten chains until the towing vehicle is level.

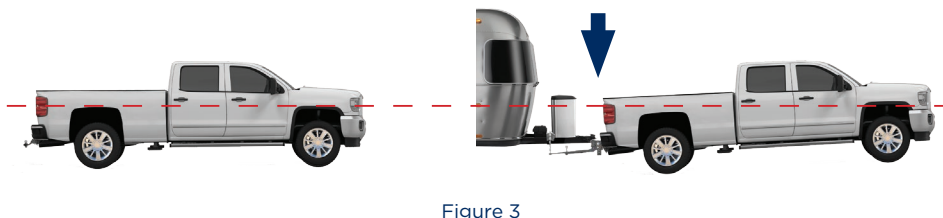

Optional & Replacement Kits

Replacement Kits

BXW4010	Kit, Rotating Latch, Clamp-On
BXW4027	Kit, Rotating Latch, Clamp-On, 8" Frame
BXW4075	Kit, Hitch Head, Pin Style
BXW4076	Kit, Hitch Head, Underslung, Pin Style
BXW4047	Kit, Pins
BXW4029	Kit, Rotating Latch, Wrench
BXW4021	Kit, Rotating Latch, Bolt-Around
BXW4023	Kit, Pole Tongue Adapter

Spring Bar Kits

BXW4015	Kit, 350 lb Spring Bars
BXW4005	Kit, 550 lb Spring Bars
BXW4006	Kit, 750 lb Spring Bars
BXW4007	Kit, 1,000 lb Spring Bars
BXW4008	Kit, 1,500 lb Spring Bars
BXW4014	Kit, 2,000 lb Spring Bars

Receivers

BXW4000	7 Hole - 9" Receiver Mount, 2" Shank
BXW4001	7 Hole - 12" Receiver Mount, 2" Shank
BXW4002	9 Hole - 9" Receiver Mount, 2" Shank
BXW4003	9 Hole - 12" Receiver Mount, 2" Shank
BXW4022	11 Hole - 10" Receiver Mount, 2" Shank
BXW4016	2 Hole - 9" Receiver Mount, 2" Shank
BXW4017	2 Hole - 12" Receiver Mount, 2" Shank
BXW4028	9 Hole - 9" Receiver Mount, 2-1/2" Shank

RECEIVER HEIGHTS

** Heights may vary slightly from what is shown depending on brand of hitch ball used. **

Drop Position

Rise Position

2 Hole Receiver

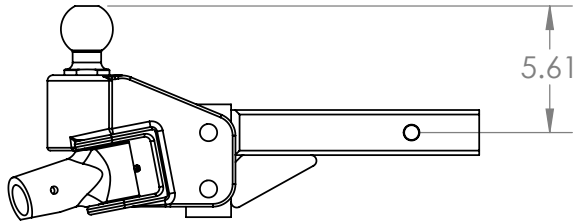

No Adjustment

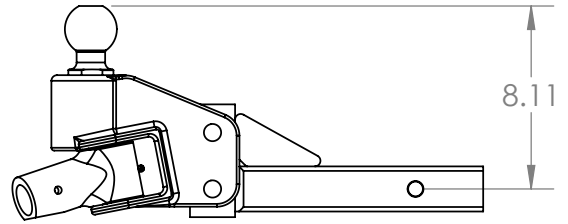

7 Hole Receiver

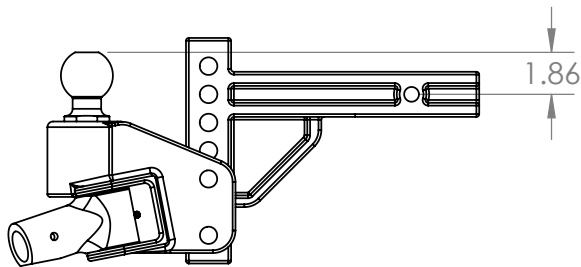

0" to 5" Adjustment

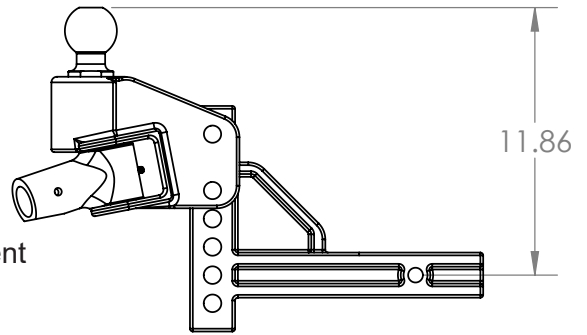

9 Hole Receiver

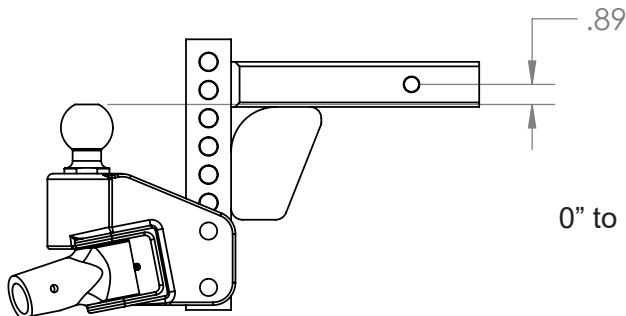

0" to 7-1/2" Adjustment

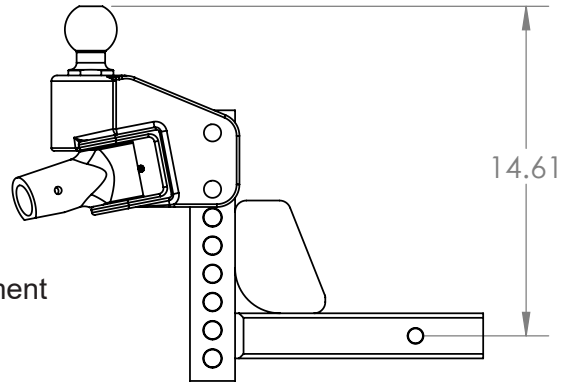

11 Hole Receiver

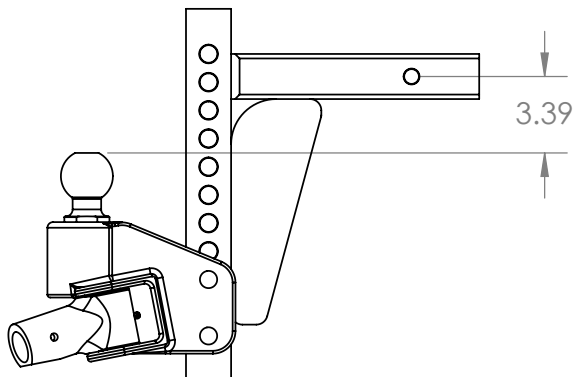

0" to 10" Adjustment

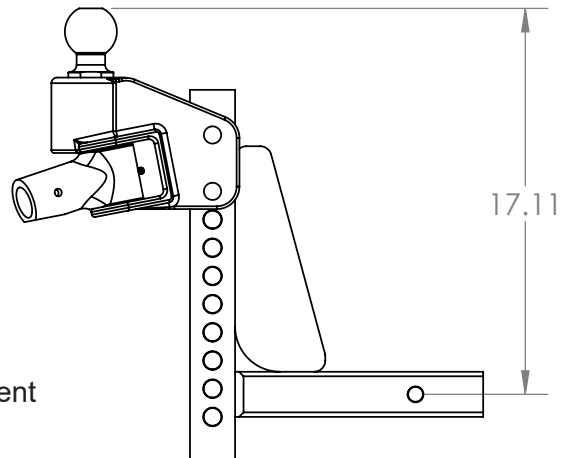

Maintenance of your SwayPro™

Maintenance

Check grease zerk on the front of **both** bar pivots before each use to ensure they are not dry. We recommend using a couple pumps of molybdenum grease on each bar pivot, at least twice a year. Wipe away excess grease after application.

Periodically grease the hitch ball with molybdenum grease.

Things To Know

The towing vehicle's loaded ball height should never be greater than it's uncoupled height. Front wheel overload and loss of rear wheel traction can occur and can lead to unstable handling, reduced braking ability, and a tendency to jackknife when turning and braking at the same time.

DO NOT attempt to tow any type of trailer behind another trailer. Towing multiple trailers may cause severe instability, loss of control and/or structural failures.

Handling and control of your towing vehicle and trailer is greatly improved when the cargo is properly loaded and distributed. It is recommended to have a tongue weight of 10-15% of the gross trailer weight.

Always use safety chains while towing. Cross chains under the coupler for proper installation and to prevent tongue from dropping to the ground. Only allow enough slack in chains for tight turns, the chains should not drag on the ground. To alleviate slack, twist chains equally from the hook end. Safety chains should be rated at equal to or greater than twice the maximum gross trailer weigh rating (GTWR).

CUSTOMER SERVICE COMMITMENT

Blue Ox® is committed to providing you with exceptional customer care throughout your lifetime with our products. Our team is here to assist you with any questions you may have regarding the performance of your product. Simply call (402) 385-3051 and you can speak with our technical service team.

Additionally, please visit our website to see which rallies our Destination America team will be attending. For a nominal fee, our service technician will service your towing system to ensure it's in proper working condition. Also, as a commitment to our customers, should you visit our factory, you can stay at our full service Blue Ox® campground at no charge along with enjoying a factory tour.

Again, thank you for being our customer and for the confidence you have shown in the performance of our products. It is because of customers like you we enjoy the success we have today.

© 2016 Blue Ox
One Mill Road, Industrial Park
Pender, Nebraska 68047
Phone: (402) 385-3051
Fax: (402) 385-3360
www.blueox.com

BLUE OX ORIGINAL PURCHASERS LIMITED LIFETIME WARRANTY

Automatic Equipment Manufacturing Company ("Automatic") warrants to the original (first) retail purchaser that this product, manufactured by Automatic, shall be free from defect in material and workmanship under normal use and service for as long as the original retail purchaser owns the product.

During said period, Automatic will repair or replace any parts that have been returned by the original purchaser, to the factory, transportation prepaid, and in Automatic's sole and absolute opinion found to be defective.

Limitations on Warranty Coverage:

Coverage under this warranty will be valid only if the customer warranty card is returned by the original purchaser within 30 days of purchase.

Coverage under this warranty will be effective only when a copy of the original invoice, showing date and place of purchase, accompanies any claim for warranty. This warranty is NON TRANSFERABLE.

This limited warranty will not cover, in any way or form, any alleged damages caused by incorrect or improper installation, improper use, modification or neglect of product, failure to properly service and maintain, misuse, act of God, accident or failure of the user to follow guidelines contained in the instructional material provided by Automatic.

This warranty does not cover normal wear and tear, paint or rust.

Warrantor assumes no responsibility to the owner for loss of use of product, loss of time, inconvenience or any other damage consequential or otherwise. Including, but not limited to mileage, expense of transporting of product, return shipping expense, mechanics travel time, telephone, road service, towing, and rental during repairs, travel, lodging, loss or damage to personal property or loss of earnings.

REPAIR OR REPLACEMENT AS SET FORTH IN THIS LIMITED WARRANTY IS THE SOLE EXCLUSIVE REMEDY OF THE PURCHASER. AUTOMATIC SHALL NOT BE LIABLE FOR ANY INCIDENTAL OR CONSEQUENTIAL DAMAGES FOR BREACH OF ANY EXPRESS OR IMPLIED WARRANTY ON THIS PRODUCT. EXCEPT TO THE EXTENT PROHIBITED BY APPLICABLE LAW, ANY IMPLIED WARRANTY OF MERCHANTABILITY OR FITNESS FOR A PARTICULAR PURPOSE ON THIS PRODUCT IS LIMITED IN LENGTH TO THE DURATION OF THIS WARRANTY.

Please visit <http://blueox.com/warranty/> to register your warranty



BLUE OX